

Assessing the role of basic control measures, antivirals and vaccine in curtailing pandemic influenza: scenarios for the US, UK and the Netherlands

M Nuño, G Chowell and A.B Gumel

J. R. Soc. Interface 2007 **4**, 505-521
doi: 10.1098/rsif.2006.0186

References

[This article cites 31 articles, 10 of which can be accessed free](#)

<http://rsif.royalsocietypublishing.org/content/4/14/505.full.html#ref-list-1>

[Article cited in:](#)

<http://rsif.royalsocietypublishing.org/content/4/14/505.full.html#related-urls>

Rapid response

[Respond to this article](#)

<http://rsif.royalsocietypublishing.org/letters/submit/royinterface;4/14/505>

Email alerting service

Receive free email alerts when new articles cite this article - sign up in the box at the top right-hand corner of the article or click [here](#)

To subscribe to *J. R. Soc. Interface* go to: <http://rsif.royalsocietypublishing.org/subscriptions>

Assessing the role of basic control measures, antivirals and vaccine in curtailing pandemic influenza: scenarios for the US, UK and the Netherlands

M. Nuño^{1,*}, G. Chowell² and A. B. Gumel³

¹*Department of Biostatistics, Harvard School of Public Health, Boston, MA 02115, USA*

²*Center for Nonlinear Studies & Mathematical Modeling and Analysis Group (MS B284), Los Alamos National Laboratory, Los Alamos, NM 87544, USA*

³*Department of Mathematics, University of Manitoba, Winnipeg, MB, Canada, R3T 2N2*

An increasing number of avian flu cases in humans, arising primarily from direct contact with poultry, in several regions of the world have prompted the urgency to develop pandemic preparedness plans worldwide. Leading recommendations in these plans include basic public health control measures for minimizing transmission in hospitals and communities, the use of antiviral drugs and vaccination. This paper presents a mathematical model for the evaluation of the pandemic flu preparedness plans of the United States (US), the United Kingdom (UK) and the Netherlands. The model is used to assess single and combined interventions. Using data from the US, we show that hospital and community transmission control measures alone can be highly effective in reducing the impact of a potential flu pandemic. We further show that while the use of antivirals alone could lead to very significant reductions in the burden of a pandemic, the combination of transmission control measures, antivirals and vaccine gives the most ‘optimal’ result. However, implementing such an optimal strategy at the onset of a pandemic may not be realistic. Thus, it is important to consider other plausible alternatives. An optimal preparedness plan is largely dependent on the availability of resources; hence, it is *country-specific*. We show that countries with limited antiviral stockpiles should emphasize their use therapeutically (rather than prophylactically). However, countries with large antiviral stockpiles can achieve greater reductions in disease burden by implementing them both prophylactically and therapeutically. This study promotes alternative strategies that may be feasible and attainable for the US, UK and the Netherlands. It emphasizes the role of hospital and community transmission control measures in addition to the timely administration of antiviral treatment in reducing the burden of a flu pandemic. The latter is consistent with the preparedness plans of the UK and the Netherlands. Our results indicate that for low efficacy and coverage levels of antivirals and vaccine, the use of a vaccine leads to the greatest reduction in morbidity and mortality compared with the singular use of antivirals. However, as these efficacy and coverage levels are increased, the use of antivirals is more effective.

Keywords: influenza; pandemic; basic reproduction number, compartmental model; antivirals; vaccination; basic control measures

1. INTRODUCTION

Recent events that include the presence of highly pathogenic avian H5N1 virus in wild bird populations in several regions of the world together with an increasing number of flu cases of H5N1 arising primarily from direct contact with poultry have highlighted the urgent need for preparedness and coordinated global strategies to effectively combat a potential influenza (flu) pandemic. To date, the 1918 influenza pandemic has been the most devastating, resulting in the death of

at least 20 million people worldwide (Stuart-Harris 1979; Nicholson *et al.* 1998). Although subsequent influenza pandemics in 1957 (‘Asian Flu’) and 1968 (‘Hong-Kong Flu’) resulted in ‘milder’ outbreaks than that of 1918, the current projections of the potential impact of a prospective pandemic are alarming (Meltzer *et al.* 1999; Blitz 2000; Center for Disease Control and Prevention 2003).

Since it is almost impossible to predict when the next flu pandemic will occur, recent human cases of bird flu call for the design of effective global surveillance and public health preparedness plans to combat the next

*Author for correspondence (mnuño@hsph.harvard.edu).

pandemic (Butler 2006). Like in most other respiratory diseases, prevention and control strategies against pandemic influenza include basic public health control measures such as increased hygiene, use of protective devices (e.g. face masks), isolation in hospital wards and quarantine of suspected cases. The use of multiple interventions to limit the disease burden associated with a pandemic has been explored in several recent studies (van Genugten *et al.* 2003; Longini *et al.* 2004, 2005; Ferguson *et al.* 2005; Gani *et al.* 2005; Germann *et al.* 2006). Although these efforts have provided several potentially effective strategies, one question still remains, namely, whether a strategy that includes (i) massive stockpiling of antivirals, (ii) targeted antiviral prophylaxis, (iii) massive pre-vaccination of high-risk individuals, (iv) pneumococcal vaccine, or (v) a combination of these interventions can be considered optimal, given that these vital (pharmaceutical) resources will be of limited supply or delayed during a pandemic (Longini *et al.* 2004, 2005; Longini & Halloran 2005). In particular, the availability of antivirals will most probably be limited in many regions, particularly in developing countries, while a vaccine is unlikely to be available shortly after the pandemic takes off (Gerdil 2003). The question then becomes, given these limitations, what is the 'optimal' intervention strategy for minimizing the burden of a pending flu pandemic?

A number of modelling studies have assessed control strategies for controlling the impact of pandemic influenza. Control strategies for pandemic influenza include the use of targeted antiviral prophylaxis (Longini *et al.* 2004), therapeutic antivirals for age and risk structured individuals (Gani *et al.* 2005) and targeted vaccination of high-risk groups and children (Longini & Halloran 2005). Longini *et al.* (2005) recently assessed the combined role of targeted prophylaxis, quarantine and pre-vaccination. Furthermore, Ferguson *et al.* (2005) studied the role of large-scale antiviral prophylaxis and social distancing measures in reducing the impact of a flu pandemic in Southeast Asia (Ferguson *et al.* 2005), and Germann *et al.* (2006) assessed similar interventions for pandemic influenza in the United States (US).

In this paper, we use a compartmental modelling approach to study the role of hospital and community control measures, antivirals and vaccination in combating a potential flu pandemic in a population of high- and low-risk individuals. We evaluated the role of intervention strategies incorporated in preparedness plans for the US, the United Kingdom (UK) and the Netherlands. We discuss the potential role of the different intervention strategies and compare our results with those reported in previous studies (van Genugten *et al.* 2003; Longini *et al.* 2004; Gani *et al.* 2005; Longini and Halloran 2005).

2. MATERIAL AND METHODS

2.1. Epidemic model with interventions

The total population is divided into two main subgroups according to their risk of infection, namely high- and low-risk individuals. The high-risk population includes

children, health-care workers and providers (including all front-line workers), the elderly and other immunocompromised individuals. The rest of the population is considered to be low-risk. The total population, denoted by $N(t)$, consists of a number of mutually exclusive subpopulations according to their epidemiological state: susceptible (S_i), latent (L_i), early-stage infectious (I_{i_1}), late-stage infectious (I_{i_2}), asymptomatic and partially infectious (A_i), hospitalized (H_i), therapeutic (T) and prophylactic (P_i) antiviral recipients, successfully vaccinated (but not yet fully protected) (V_i), fully protected via vaccination (C), recovered (R) and disease-induced dead (D) individuals where the index i is used to denote the high- (h) and low-risk (l) individuals. Treatment with antivirals is administered only to infectious individuals at an early symptomatic stage since the success of antiviral treatment relies upon its timely administration within 48 h of illness onset (Monto 2003; Moscona 2005).

Susceptible individuals in the i -risk class (S_i) may acquire temporary protection through antiviral prophylaxis at a rate ρ_i with antiviral efficacy ϵ_{A_i} ($0 < \epsilon_{A_i} < 1$) or vaccination, at a rate ν_i with vaccine efficacy ϵ_{V_i} . Protected individuals who interrupt antiviral use return to the susceptible class at a rate σ_i . Successfully vaccinated individuals (V_i) acquire protective antibody levels at a rate κ_i , progressing to the protected class C . Moreover, prophylactic antiviral recipients are vaccinated at a rate ν_i . Susceptible individuals may acquire infection following contact with symptomatic (i.e. infectious) ($I_{i_1} + I_{i_2}$), asymptomatic (assumed to be partially infectious) (A_i) or hospitalized individuals (H_i), with a force of infection λ_i . The force of infection for the i -risk susceptible individuals, λ_i in system (2.1), is given by $\lambda_i = \beta_i \sum_{j=l,h} (\pi_j (I_{j_1} + I_{j_2} + \eta_j A_j) + \zeta_j H_j) / N$, where $0 < \eta_j < 1$ models the relative infectiousness of asymptomatic individuals (in relation to those with symptoms). The parameters $0 < \pi_i \leq 1$ and $0 < \zeta_i \leq 1$ represent the reduction factors of disease transmission in the community and hospitals, respectively, owing to the use of control measures in these settings. Similarly, the force of infection for i -risk vaccinated individuals is given by $\lambda_{V_i} = (1 - \epsilon_{V_i}) \beta_i \sum_{j=l,h} (\pi_j (I_{j_1} + I_{j_2} + \eta_j A_j) + \zeta_j H_j) / N$. A proportion, a_i , of individuals in the latent stage (i.e. individuals infected but not yet infectious) are assumed to be treated with antiviral drugs at a rate θ_i . A fraction, p , of the untreated latent individuals ($1 - a_i$) progress to the symptomatic class (I_{i_1}) at a rate ϕ_i , and the remaining fraction, $1 - p$, progress to the asymptomatic class (A_i) at the rate ϕ_i . A fraction, q_i , of i -risk infectious individuals in the early symptomatic stage (I_{i_1}) receive antiviral treatment at a rate ξ_i , with efficacy ϵ_{A_i} . The remaining fraction, $1 - q_i$, of early-stage infectious individuals progress to the late infectious stage (I_{i_2}) at a rate ψ_i . The remaining fraction of unsuccessfully treated individuals, $(1 - \epsilon_{A_i} q_i)$, naturally progress to the I_{i_2} class at a rate ψ_i . Asymptomatic individuals receive antiviral treatment at the rate θ_i . Individuals in the late infectious class (I_{i_2}) are hospitalized at a rate α_i or recover at a rate γ_{I_i} . Asymptomatic individuals recover at a rate γ_{A_i} (for simplicity, we assume $\gamma_{A_i} = \gamma_{I_i}$), while the therapeutic

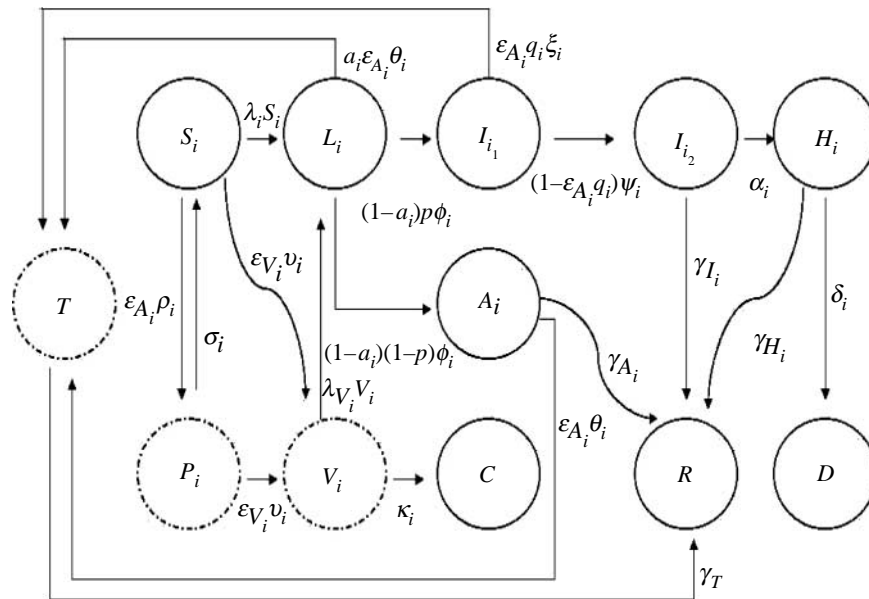

Figure 1. Flowchart diagram describing the high- and low-risk populations considered in model (2.1), where the index i denotes the high- ($i=h$) and low-risk ($i=l$) classes. The implementation of antiviral prophylactically is only available to susceptibles (S_i), while therapeutic antivirals may be given to exposed (L_i), early-stage infectious (I_{i_1}) and asymptomatic (A_i) individuals. C and D classes are the populations of protected (via vaccination) and deceased cases, respectively.

antiviral recipients recover at a rate γ_T (where $\gamma_{I_i} \leq \gamma_T$). Hospitalized individuals either recover at a rate γ_{H_i} ($\gamma_{I_i} \leq \gamma_{H_i}$) or suffer disease-induced death at a rate δ_i . The mortality rate (δ_i) is obtained from the case-fatality proportion given by $\delta_i = ((CFP_i)/(1 - CFP_i))\gamma_{H_i}$, where CFP_i is the class-dependent case-fatality proportion. The model is given by the following deterministic system of differential equations (where a dot represents differentiation with respect to time). A schematic description of the model is depicted in figure 1.

$$\left. \begin{aligned}
 \dot{S}_i &= \sigma_i P_i - (\epsilon_{A_i} \rho_i + \epsilon_{V_i} \nu_i + \lambda_i) S_i, \\
 \dot{L}_i &= \lambda_i S_i + \lambda_{V_i} V_i - (a_i \epsilon_{A_i} \theta_i + (1 - a_i) \phi_i) L_i, \\
 \dot{A}_i &= (1 - a_i)(1 - p) \phi_i L_i - (\epsilon_{A_i} \theta_i + \gamma_{A_i}) A_i, \\
 \dot{I}_{i_1} &= (1 - a_i) p \phi_i L_i - [\epsilon_{A_i} \xi_i q_i + (1 - q_i) \psi_i + (1 - \epsilon_{A_i}) q_i \psi_i] I_{i_1}, \\
 \dot{I}_{i_2} &= [(1 - \epsilon_{A_i}) q_i \psi_i + (1 - q_i) \psi_i] I_{i_1} - (\gamma_{I_i} + \alpha_i) I_{i_2}, \\
 \dot{H}_i &= \alpha_i I_{i_2} - (\gamma_{H_i} + \delta_i) H_i, \\
 \dot{P}_i &= \epsilon_{A_i} \rho_i S_i - (\sigma_i + \epsilon_{V_i} \nu_i) P_i, \\
 \dot{T} &= \epsilon_{A_i} \sum_{i=h,l} (a_i \theta_i L_i + q_i \xi_i I_{i_1} + \theta_i A_i) - \gamma_T T, \\
 \dot{V}_i &= \epsilon_{V_i} \nu_i P_i + \epsilon_{V_i} \nu_i S_i - (\lambda_{V_i} + \kappa_i) V_i, \\
 \dot{R} &= \sum_{i=h,l} (\gamma_{A_i} A_i + \gamma_{I_i} I_{i_2} + \gamma_{H_i} H_i) + \gamma_T T, \\
 \dot{C} &= \sum_{i=h,l} \kappa_i V_i, \\
 \dot{D} &= \sum_{i=h,l} \delta_i H_i.
 \end{aligned} \right\} \quad (2.1)$$

System (2.1) does not include demographic changes such as birth, natural deaths and migration because the time-scale of the pandemic is assumed to be short (days–months) when compared with that of demographic changes (which may span several decades).

2.1.1. Epidemic threshold numbers. We evaluate the likelihood that an outbreak may take-off in the absence of transmission control measures, antivirals and vaccine via the overall *basic reproduction number* given by $\mathcal{R}_0 = \max(\mathcal{R}_0^h, \mathcal{R}_0^l)$, where \mathcal{R}_0^h and \mathcal{R}_0^l describe the *basic reproduction number* of high- and low-risk individuals, respectively. We calculate \mathcal{R}_0^i using the next generation operator method (Diekmann et al. 1990; van den Driessche & Watmough 2002). This epidemiological quantity measures the average number of new cases generated by an infectious individual, for the duration of his/her infectiousness, in a completely susceptible population. It can be shown that, for the model (2.1),

$$\mathcal{R}_0^i = \left(\frac{\beta_i \eta_i (1 - p)}{\gamma_{A_i}} + \frac{\beta_i p}{\psi_i} + \frac{\beta_i p}{(\gamma_{I_i} + \alpha_i)} + \frac{\beta_i p \alpha_i}{(\gamma_{I_i} + \alpha_i)(\gamma_{H_i} + \delta_i)} \right) S_i^0, \quad (2.2)$$

where $S_i^0 = S_i(0)$ is the initial population of susceptible individuals in the community. It is assumed that $S_i^0 \approx N^0$, where $N^0 = N(0)$ is the initial total population, during the initial phase of an outbreak. In the presence of hospital and community control measures, the corresponding *control reproduction number* is given by

$$\mathcal{R}_c^i = \left(\frac{\pi_i \beta_i \eta_i (1 - p)}{\gamma_{A_i}} + \frac{\pi_i \beta_i p}{\psi_i} + \frac{\pi_i \beta_i p}{(\gamma_{I_i} + \alpha_i)} + \frac{\zeta_i \beta_i p \alpha_i}{(\gamma_{I_i} + \alpha_i)(\gamma_{H_i} + \delta_i)} \right) S_i^0. \quad (2.3)$$

It is evident from (2.3) that \mathcal{R}_c^i becomes \mathcal{R}_0^i in the absence of the aforementioned hospital and community control measures ($\pi_i = \zeta_i = 1$).

In order to evaluate the effectiveness of a vaccination programme in combatting a flu pandemic, we first consider the scenario where a vaccine is the sole

intervention adopted. The associated *vaccination reproduction number* is given by

$$\mathcal{R}_v^i = \left(\frac{\beta_i \eta_i (1-p)}{\gamma_{A_i}} + \frac{\beta_i p}{\psi_i} + \frac{\beta_i p}{(\gamma_{I_i} + \alpha_i)} + \frac{\beta_i p \alpha_i}{(\gamma_{I_i} + \alpha_i)(\gamma_{H_i} + \delta_i)} \right) \mathcal{S}_{\text{eff}}^0, \quad (2.4)$$

where $\mathcal{S}_{\text{eff}}^0 = (S_i^0 + (1 - \epsilon_{V_i}) V_i^0) / N^0$ and $V_i^0 = V_i(0)$ are the initial population of vaccinated individuals. Similarly, for the antiviral-only scenario, the corresponding *antiviral reproduction number* is given by

$$\mathcal{R}_{\text{av}}^i = \left(\frac{\beta_i \eta_i (1-a_i)(1-p)\phi_i}{\mathcal{B}_i \mathcal{C}_i} + \frac{\beta_i x_i}{\mathcal{A}_i \mathcal{B}_i} + \frac{\beta_i x_i y_i}{\mathcal{A}_i \mathcal{B}_i \mathcal{D}_i} + \frac{\beta_i x_i y_i \alpha_i}{\mathcal{A}_i \mathcal{B}_i \mathcal{D}_i \mathcal{E}_i} \right) \mathcal{S}_i^0, \quad (2.5)$$

where $x_i = (1 - a_i)p\phi_i$, $y_i = (1 - \epsilon_{A_i} q_i)\psi_i$, $\mathcal{A}_i = \epsilon_{A_i} \xi_i q_i + (1 - \epsilon_{A_i} q_i)\psi_i$, $\mathcal{B}_i = a_i \epsilon_{A_i} \theta_i + (1 - a_i)\phi_i$, $\mathcal{C}_i = (\epsilon_{A_i} \theta_i + \gamma_{A_i})$, $\mathcal{D}_i = \gamma_{I_i} + \alpha_i$, $\mathcal{E}_i = \gamma_{H_i} + \delta_i$ and $\mathcal{S}_i^0 = S_i^0 / N^0$. For the case where all the three aforementioned strategies are used, the corresponding *combined reproduction number* is given by

$$\mathcal{R}_{\text{c+v+av}}^i = \left(\frac{\pi_i \beta_i \eta_i (1-a_i)(1-p)\phi_i}{\mathcal{B}_i \mathcal{C}_i} + \frac{\pi_i \beta_i x_i}{\mathcal{A}_i \mathcal{B}_i} + \frac{\pi_i \beta_i x_i y_i}{\mathcal{A}_i \mathcal{B}_i \mathcal{D}_i} + \frac{\zeta_i \beta_i x_i y_i \alpha_i}{\mathcal{A}_i \mathcal{B}_i \mathcal{D}_i \mathcal{E}_i} \right) \mathcal{S}_{\text{eff}}^0, \quad (2.6)$$

with \mathcal{A}_i , \mathcal{B}_i , \mathcal{C}_i , \mathcal{D}_i and \mathcal{E}_i as defined in the expression for $\mathcal{R}_{\text{av}}^i$ and $\mathcal{S}_{\text{eff}}^0 = (S_i^0 + (1 - \epsilon_{V_i}) V_i^0) / N^0$.

The epidemiological significance of the *combined reproduction number*, which represents the average number of new cases generated by a primary infectious individual in a population where the combined interventions are implemented, is that the pandemic can be effectively controlled if the combined interventions can bring this threshold quantity to a value less than unity (the pandemic would persist otherwise). Thus, it is instructive to gain insight into the epidemiological and biological processes that contribute to this quantity. A detailed description of the terms that contribute to $\mathcal{R}_{\text{c+v+av}}^i$ is given in appendix A.

2.2. Pandemic flu preparedness plans

Many nations around the world have formulated their preparedness plan in the anticipation of the pending influenza pandemic (Uscher-Pines *et al.* 2006). These plans are aimed at minimizing the burden of the pandemic (e.g. morbidity and mortality) while minimizing social disruption. In comparison with seasonal influenza, it is reasonable to assume that a flu pandemic would offer more challenge to public health care systems worldwide since the emerging pandemic strain is expected to differ significantly from the prevailing circulating (seasonal) flu strain. Consequently, the population would have little or no immunity to the incoming strain, potentially leading to high morbidity and disease mortality. Furthermore, uncertainty on the availability of intervention resources and logistical issues associated with their distribution may pose additional challenges for effective control.

The pandemic preparedness plans for the US, UK and the Netherlands are similar in that they include the use of interventions such as antivirals, vaccine, isolation and quarantine to name but a few. However, a key difference between these plans is that while the US recommends the immediate use of antiviral treatment and targeted prophylaxis, the UK and the Netherlands plans do not recommend extensive use of antiviral prophylaxis. For instance, the UK Plan recommends the use of antivirals largely therapeutically, with the exception of prophylaxis among occupational groups exposed to dead or diseased birds, while the Netherlands plan recommends the use of antivirals primarily as therapeutics. A further difference among these plans is the recommendation of pneumococcal immunization of high-risk groups (primarily the elderly) in the UK and the Netherlands plans, but not in the US plan.

3. RESULTS

Numerical simulations of the model (2.1) are carried out by solving the system using an appropriate integrator. The model is initially calibrated assuming a baseline of no interventions ('worse-case scenario'). Parameter description, assumed values and country-specific demographic assumptions are provided in tables 1–3, respectively. Since we are interested in comparing our results with those obtained in earlier studies in the literature that have assessed several scenarios for these countries (e.g. US studies by Longini *et al.* (2004), Longini & Halloran (2005), Germann *et al.* (2006) and Ferguson *et al.* (2006); the UK study by Gani *et al.* (2005); and the Netherlands study by van Genungten *et al.* (2003)), we provide baseline estimates used in these studies (table 3). Although most of our results for different scenarios were obtained using a basic reproduction number of 1.9 (no interventions), the cumulative number of infections, hospitalizations and deaths are provided for several values of \mathcal{R}_0 (table 4).

3.1. Evaluation scenarios for the US

3.1.1. Basic public health measures. The impact of basic public health measures (transmission control measures) in reducing the burden of a pandemic is explored first. These measures generally include reductions in the transmission rate within the general community through, for example, increased hygiene and reductions in the number of contacts with infectious individuals, and effective isolation of infectious individuals in hospital settings. First, we consider the possibility that basic public health measures are implemented only partially and allow reduction levels in the transmission rate to vary between 50 and 90%. For instance, we analyse the case in which transmission control measures are implemented *either* in hospitals ($\pi_i = 1$, $\zeta_i \in (0.1, 0.5)$) *or* in community settings ($\zeta_i = 1$, $\pi_i \in (0.1, 0.5)$) only. The results, tabulated in table 5, show that implementing control measures in the general community is more effective than implementing them in hospitals (the former can result in up to 94% reduction of disease burden in comparison

Table 1. Parameter definitions and corresponding references that support their corresponding values in table 2. The index i is used to denote the high-risk (h) and low-risk (l) classes.

parameter	definition	reference
\mathcal{R}_0^i	basic reproduction number	Mills <i>et al.</i> (2004)
η_i	relative infectiousness of asymptomatic individuals	Gani <i>et al.</i> (2005)
p	fraction of non-treated latent individuals that progress to symptomatic class	Gani <i>et al.</i> (2005)
$1/\phi_i$	latent period (days)	Longini <i>et al.</i> (2004) and Mills <i>et al.</i> (2004)
ψ_i	disease progression rate to late-infectious class (days ⁻¹)	Mills <i>et al.</i> (2004)
α_i	hospitalization rate (days ⁻¹)	Gani <i>et al.</i> (2005)
γI_i	recovery rate for infectious individuals (days ⁻¹)	Stiver (2003) and Longini <i>et al.</i> (2004)
γA_i	recovery rate for asymptomatic individuals (days ⁻¹)	Stiver (2003) and Longini <i>et al.</i> (2004)
γH_i	recovery rate for hospitalized individuals (days ⁻¹)	Stiver (2003) and Longini <i>et al.</i> (2004)
CFP _{i}	case-fatality proportion for i -risk individuals	Thompson <i>et al.</i> (2004)
δ_i	mortality rate (days ⁻¹), $\delta_i = ((\text{CFP}_i)/(1 - \text{CFP}_i))\gamma H_i$	Gani <i>et al.</i> (2005)
π_i	community transmission reduction parameter	Longini <i>et al.</i> (2004)
ζ_i	relative infectiousness of hospitalized individuals	Gani <i>et al.</i> (2005)
q_i	fraction of therapeutic antiviral recipients	Meltzer <i>et al.</i> (1999)
a_i	fraction of latent individuals that are treated with antiviral medication	Gani <i>et al.</i> (2005)
ϵ_{A_i}	antiviral efficacy	Longini <i>et al.</i> (2004) and Moscona (2005)
σ_i	average protection rate via prophylaxis (days ⁻¹)	Oxford <i>et al.</i> (2002)
ρ_i	prophylactic antiviral rate (days ⁻¹)	Longini <i>et al.</i> (2004)
θ_i	therapeutic antiviral rate for latent and asymptomatic individuals (days ⁻¹)	Longini <i>et al.</i> (2004)
ξ_i	therapeutic antiviral rate (days ⁻¹)	Oxford <i>et al.</i> (2002)
γ_T	recovery rate of treated individuals (days ⁻¹)	Stiver (2003) and Longini <i>et al.</i> (2004)
ϵ_{V_i}	vaccine efficacy	Demicheli <i>et al.</i> (2004), Goodwin <i>et al.</i> (2005) and Jefferson <i>et al.</i> (2005)
ν_i	vaccination rate (days ⁻¹)	Longini & Halloran (2005)
κ_i	vaccine-induced protection rate (days ⁻¹)	Potter & Oxford (1979), Cox <i>et al.</i> (2004) and Longini & Halloran (2005)

with the baseline for the case where $\mathcal{R}_0 = 1.9$, given in table 4). Moreover, reducing hospital transmission by 20% ($\zeta_i = 0.8$) or community transmission by the same amount ($\pi_i = 0.8$), while the other measure is varied between 50 and 90%, gives results of similar pattern, where the 20% reduction in the community led to about 99.9% decrease in mortality (624) and morbidity (24 812).

Further simulations for the impact of transmission measures in *either* hospitals or communities, as well as in *both* settings, are carried out for several levels of control efficacy (table 6). For instance, a 95% reduction in hospital transmission and no reduction in community transmission ($\pi_i = 1$, $\zeta_i = 0.05$) results in 611 110 deaths, 7.8 million hospitalizations and 16 million infections, while a similar reduction in community transmission and no reduction in hospital transmission ($\pi_i = 0.05$, $\zeta_i = 1$) leads to 10 deaths, 117 hospitalizations and 231 infections (table 6). Implementing these measures simultaneously (so that $\pi_i < 1$, $\zeta_i < 1$) can further reduce these estimates to as few as 7 deaths, 77 hospitalizations and 150 infections. Overall, these simulations show that if control measures were to be implemented in a single setting, their implementation in the general community is more beneficial than their implementation in hospitals.

The results tabulated in table 6 are further illustrated graphically in figure 2, from which it is

clear that a programme based on reducing hospital transmission alone (and no reduction in community transmission; $\pi_i = 1$) requires almost 100% reduction in hospital transmission to reduce morbidity and mortality significantly (figure 2a). Combining hospital transmission control measures with a 20% reduction in community transmission ($\pi_i = 0.8$) shows that a 70% ($1 - \zeta_i \approx 0.3$) reduction in hospital transmission is sufficient to significantly reduce morbidity and mortality (figure 2c). Similarly, combining community transmission control measures with a 20% reduction in hospital transmission reduces the corresponding needed effort, from 60% ($1 - \pi_i \approx 0.4$) reduction in community transmission control to 50% (figure 2b,d).

Since, to the best of our knowledge, the impact of hospital control measures in combatting a potential flu pandemic has not been fully modelled in the aforementioned earlier studies, we further investigate the 'role' of these interventions for several pandemic scenarios (corresponding to $\mathcal{R}_0 = 1.6, 1.9, 2.1$ and 2.4). Figure 3 shows that reductions in hospital control measures necessary to significantly minimize morbidity and mortality depend strongly on \mathcal{R}_0 . For instance, assuming a baseline \mathcal{R}_0 of 1.6, we show that a 30% reduction in hospital transmission ($1 - \zeta_i = 0.7$) results in a dramatic decrease in the burden of a pandemic. However, as \mathcal{R}_0 increases from 1.9 to 2.1, higher reduction levels of hospital transmission are needed

Table 2. Parameters for high- and low-risk individuals for each intervention plan studied. Parameter ranges are provided whenever applicable. Upper-bound (ub) and low-bound (lb) parameters correspond to the high and low values provided in each range.

parameter	no interventions (high-risk: low-risk)	control measures (high-risk: low-risk)	antiviral intervention (high-risk: low-risk)	vaccine intervention (high-risk: low-risk)
\mathcal{R}_0^i	(1.6–2.4 : 1.2–2)	(1.9 : 1.5)	(1.9 : 1.5)	(1.9 : 1.5)
η_i	(0.5 : 0.5)	(0.5 : 0.5)	(0.5 : 0.5)	(0.5 : 0.5)
p	(0.5 : 0.5)	(0.5 : 0.5)	(0.5 : 0.5)	(0.5 : 0.5)
ϕ_i	(1/1.9 : 1/1.9)	(1/1.9 : 1/1.9)	(1/1.9 : 1/1.9)	(1/1.9 : 1/1.9)
ψ_i	(1/2 : 1/2)	(1/2 : 1/2)	(1/2 : 1/2)	(1/2 : 1/2)
α_i	(1/4 : 1/5)	(1/4 : 1/5)	(1/4 : 1/5)	(1/4 : 1/5)
γ_{I_i}	(1/5 : 1/4)	(1/5 : 1/4)	(1/5 : 1/4)	(1/5 : 1/4)
γ_{A_i}	(1/5 : 1/4)	(1/5 : 1/4)	(1/5 : 1/4)	(1/5 : 1/4)
γ_{H_i}	(1/7 : 1/5)	(1/7 : 1/5)	(1/7 : 1/5)	(1/7 : 1/5)
CFP _{<i>i</i>}	(0.15 : 0.03)	(0.15 : 0.03)	(0.15 : 0.03)	(0.15 : 0.03)
δ_i	(1/33 : 1/100)	(1/33 : 1/100)	(1/33 : 1/100)	(1/33 : 1/100)
π_i	(1 : 1)	(0–1 : 0–1)	(1 : 1)	(1 : 1)
ζ_i	(1 : 1)	(0–1 : 0–1)	(1 : 1)	(1 : 1)
q_i	(0 : 0)	(0 : 0)	(0.3–0.7 : 0.1–0.5)	(0 : 0)
a_i	(0 : 0)	(0 : 0)	(0.15–0.35 : 0.05–0.25)	(0 : 0)
ϵ_{A_i}	(0 : 0)	(0 : 0)	(0.3–0.5 : 0.5–0.7)	(0 : 0)
σ_i	(0 : 0)	(0 : 0)	(1/14 : 1/7)	(0 : 0)
ρ_i	(0 : 0)	(0 : 0)	(1/3 : 1/5)	(0 : 0)
θ_i	(0 : 0)	(0 : 0)	(1/3 : 1/5)	(0 : 0)
ξ_i	(0 : 0)	(0 : 0)	(1 : 0.67)	(0 : 0)
γ_T	(0 : 0)	(0 : 0)	(1/3) ^a	(0 : 0)
ϵ_{V_i}	(0 : 0)	(0 : 0)	(0 : 0)	(0.3–0.5 : 0.7–0.9)
ν_i	(0 : 0)	(0 : 0)	(0 : 0)	(1/2.7–1/1.5 : 1/2.7–1/1.5)
κ_i	(0 : 0)	(0 : 0)	(0 : 0)	(1/7 : 1/7)

^a This is not a risk-specific parameter.

Table 3. Initial conditions used for the US, UK and the Netherlands. Baseline estimates used in previous studies.

	US	UK	Netherlands
population size	298 444 215 ^a	60 609 153 ^a	16 491 461 ^a
high-risk (%)	20	10	10
low-risk (%)	80	90	90
initial conditions			
S_h, S_l	$6 \times 10^7, 2.4 \times 10^8$	$6.1 \times 10^6, 54.9 \times 10^6$	$1.65 \times 10^6, 14.85 \times 10^6$
$(E_{i_1}), E_{i_2}$	50, 50	50, 50	50, 50
I_{i_1}, I_{i_2}	1, 1	1, 1	1, 1
baseline from the literature ^b			
\mathcal{R}_0	1.4–2.4	1.28–2.0	1.68–1.89
case-fatality percentage (%)	0.37–2.5	0.3–3	0.06–0.67
clinical attack rate (%)	25–50	30–50	30–50
hospitalization rate (%)	0.55	0.1	0.06–4

^a Statistics assessed: July 2006 (The World Factbook 2006).

^b Estimates obtained from the literature: US (Longini *et al.* 2004; Longini & Halloran 2005; Germann *et al.* 2006), UK (Gani *et al.* 2005) and the Netherlands (van Genugten *et al.* 2002, 2003).

(increasing from 70% for $\mathcal{R}_0=1.9$ to almost 80% for $\mathcal{R}_0=2.1$; figure 3). However, when $\mathcal{R}_0=2.4$, figure 3*d* shows that the impact of hospital control measures on morbidity and mortality is greatly reduced (to almost an insignificant level).

3.1.2. Antiviral-only intervention. Here, we assume that antivirals administered therapeutically, prophylactically or in combination are the only interventions

adopted. The impact of the potential uncertainty involved in the use of such interventions (measured primarily in terms of uncertainty in antiviral efficacy and coverage rate) is explored. Our simulations assume several scenarios that can be classified as ‘optimistic’ and ‘less optimistic’. In the optimistic scenario, we assume high antiviral efficacy and coverage rates (upper-bound parameters in table 2). Similarly, the less optimistic scenario assumes lower-bound parameter values for the antiviral efficacy and coverage

Table 4. Baseline estimates (no intervention) for the cumulative number of infections, hospitalizations and deaths for several basic reproduction numbers (\mathcal{R}_0) for the US, UK and the Netherlands. M, million; clinical attack rate (CAR) denotes the ratio of total infections and total population size; case-fatality percentage (CFP) denotes the ratio of deceased individuals and total infections. Baseline estimates provided by model in §2.1, where $\mathcal{R}_0 = \max\{\mathcal{R}_0^h, \mathcal{R}_0^k\}$.

\mathcal{R}_0	infections (M)	hospitalizations (M)	deaths	CAR (%)	CFP (%)
US					
1.6	95	47	3.8 M	31	4
1.9	128	64	5.1 M	43	4
2.1	140	70	6 M	48	4.3
2.4	154	77	6.1 M	52	4
UK					
1.6	19	9	683 240	31	3.6
1.9	26	13	933 514	43	3.6
2.1	28	14	1 M	48	3.6
2.4	31	16	1.1 M	51	3.5
Netherlands					
1.6	5.1	2.5	184 815	30	3.6
1.9	7	3.5	252 511	42	3.6
2.1	7.5	3.9	275 697	48	3.7
2.4	8.5	4.2	304 917	51	3.6

Table 5. Mean results of 100 simulations generated by uniformly sampling the antiviral and vaccine efficacies from appropriate ranges as assumed in each scenario. Baseline scenario assumes $\mathcal{R}_0=1.9$. The mean number of deceased (D_{mean}), hospitalized (H_{mean}), infections (I_{mean}), antiviral treatment (T_{mean}), antiviral prophylaxis (P_{mean}) and vaccinated (C_{mean}) individuals. The antiviral-only scenario considers lower- and upper-bound parameters for treatment and prophylaxis, treatment only and prophylaxis antivirals only, respectively. M, million; na, not applicable; ub and lb, upper- and lower-bound parameters presented in table 2.

single interventions	D_{mean}	H_{mean}	I_{mean}	T_{mean}	P_{mean}	C_{mean}
control measures only ^a						
$\pi_i=1, \zeta_i \in (0.1, 0.5)$	2.8 M	33 M	67 M	na	na	na
$\zeta_i=1, \pi_i \in (0.1, 0.5)$	296 210	3.8 M	7.7 M	na	na	na
$\zeta_i=0.8, \pi_i \in (0.1, 0.5)$	624	8121	16 691	na	na	na
$\pi_i=0.8, \zeta_i \in (0.1, 0.5)$	470 775	6 M	12 M	na	na	na
antiviral only ^b						
lb: $\epsilon_{A_i}, q_i, a_i, \epsilon_{A_h} \in (0.3, 0.5)$	15	194	426	141	124×10^8	na
lb: $\epsilon_{A_i}, q_i, a_i, \epsilon_{A_k} \in (0.5, 0.7)$	13	168	368	127	133×10^8	na
lb: $\epsilon_{A_i}, q_i, a_i, \rho_i = \sigma_i = 0, \epsilon_{A_h} \in (0.3, 0.5)$	3.7 M	47M	105 M	35 M	na	na
lb: $\epsilon_{A_i}, q_i, a_i, \rho_i = \sigma_i = 0, \epsilon_{A_k} \in (0.5, 0.7)$	3.7 M	47 M	105 M	36 M	na	na
lb: $\rho_i, \sigma_i, q_i = a_i = \theta_i = 0, \epsilon_{A_k} = 0.5, \epsilon_{A_h} \in (0.3, 0.5)$	51	668	1332	na	124×10^8	na
lb: $\rho_i, \sigma_i, q_i = a_i = \theta_i = 0, \epsilon_{A_h} = 0.3, \epsilon_{A_k} \in (0.5, 0.7)$	38	481	958	na	133×10^8	na
ub: $\epsilon_{A_i}, q_i, a_i, \epsilon_{A_h} \in (0.3, 0.5)$	3	38	127	109	145×10^8	na
ub: $\epsilon_{A_i}, q_i, a_i, \epsilon_{A_k} \in (0.5, 0.7)$	3	41	135	112	137×10^8	na
ub: $\epsilon_{A_i}, q_i, a_i, \rho_i = \sigma_i = 0, \epsilon_{A_h} \in (0.3, 0.5)$	483	6138	21 537	17 505	na	na
ub: $\epsilon_{A_i}, q_i, a_i, \rho_i = \sigma_i = 0, \epsilon_{A_k} \in (0.5, 0.7)$	35 836	500 799	1.7 M	1.2 M	na	na
ub: $\rho_i, \sigma_i, q_i = a_i = \theta_i = 0, \epsilon_{A_k} = 0.7, \epsilon_{A_h} \in (0.3, 0.5)$	19	236	468	na	145×10^8	na
ub: $\rho_i, \sigma_i, q_i = a_i = \theta_i = 0, \epsilon_{A_h} = 0.5, \epsilon_{A_k} \in (0.5, 0.7)$	24	305	606	na	137×10^8	na
vaccine only ^c						
lb: $\nu_I, \epsilon_{V_h} = 0.3, \epsilon_{V_k} \in (0.7, 0.9)$	9	91	177	na	na	300 M
lb: $\nu_I, \epsilon_{V_k} = 0.7, \epsilon_{V_h} \in (0.3, 0.5)$	10	106	208	na	na	300 M
ub: $\nu_i, \epsilon_{V_h} = 0.3, \epsilon_{V_k} \in (0.7, 0.9)$	8	86	175	na	na	300 M
ub: $\nu_I, \epsilon_{V_k} = 0.7, \epsilon_{V_h} \in (0.3, 0.5)$	7	76	148	na	na	300 M

^a Mean of 100 simulations sampled from $(\zeta_i, \pi_i) \in (0.1, 0.5)$.

^b Mean of 100 simulations sampled from $\epsilon_{A_h} \in (0.3, 0.5)$ and $\epsilon_{A_k} \in (0.5, 0.7)$.

^c Mean of 100 simulations sampled from $\epsilon_{V_h} \in (0.3, 0.5)$ and $\epsilon_{V_k} \in (0.7, 0.9)$.

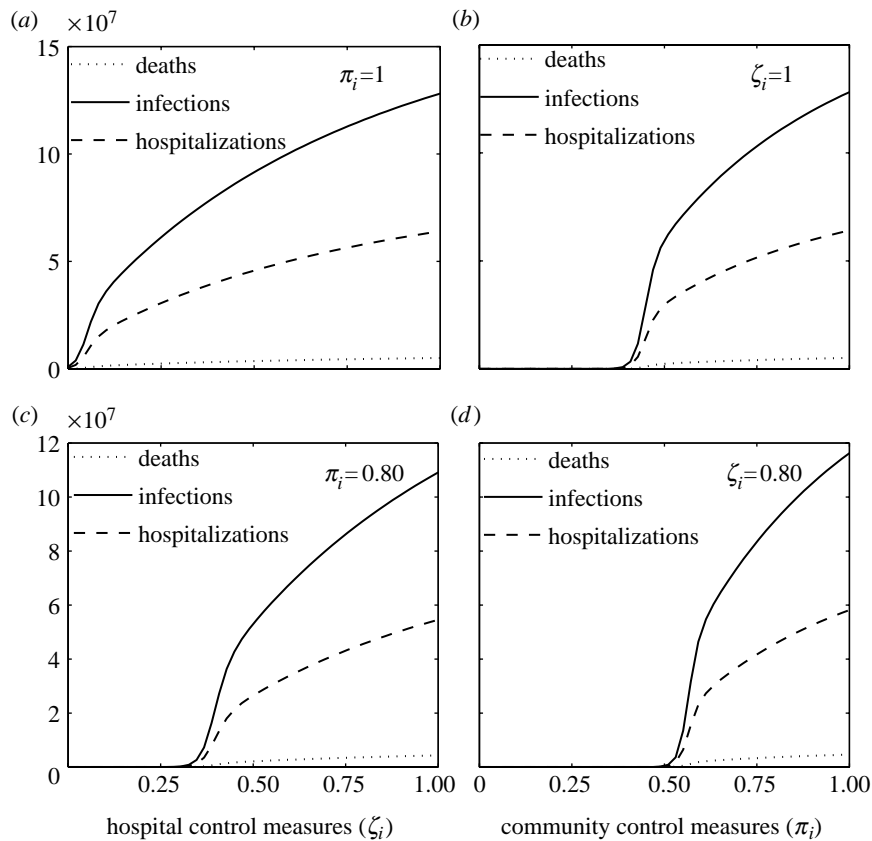

Figure 2. The final number of deaths (dotted line), hospitalizations (dashed line) and infections (solid line) for varying reduction factors in hospital ($1-\zeta_i$) and community settings ($1-\pi_i$). (a, b) Single control measures *either* in hospitals (a, $\pi_i=1$) or in community (b, $\zeta_i=1$). (c, d) Control measures in *both* of these settings. We assume $\mathcal{R}_0=1.9$.

Table 6. Baseline estimates ($\mathcal{R}_0=1.9$) for the final cumulative deaths, hospitalizations and total cases for various scenarios of control measures in hospital and community settings. Parameters $1-\pi_i$ and $1-\zeta_i$ denote efficacies of transmission control measures in communities and hospitals, respectively. M, million.

π_i	ζ_i	reduction factors (%)		deaths	hospitalizations	infections
		$1-\pi_i$	$1-\zeta_i$			
1	0.05	0, 95		611 110	7.8 M	16 M
1	0.2875	0, 71.25		2.7 M	33 M	67 M
1	0.525	0, 47.5		3.7 M	47 M	94 M
1	0.7625	0, 23.75		4.5 M	57 M	113 M
1	1	0, 0		5.1 M	64 M	128 M
0.05	1	95, 0		10	117	231
0.2875	1	71.25, 0		136	1714	3438
0.525	1	47.5, 0		3 M	33 M	66 M
0.7625	1	23.75, 0		4 M	52 M	105 M
1	1	0, 0		5.1 M	64 M	128 M
0.8	0.05	20, 95		21	254	505
0.8	0.2875	20, 71.25		3522	45 088	92 226
0.8	0.525	20, 47.5		2 M	29 M	57 M
0.8	0.7625	20, 23.75		3.5 M	44 M	88 M
0.8	1	20, 0		4.3 M	55 M	109 M
0.05	0.8	95, 20		7	77	150
0.2875	0.8	71.25, 20		17	208	412
0.525	0.8	47.5, 20		87 646	1.2 M	2.4 M
0.7625	0.8	23.75, 20		3.4 M	43 M	85 M
1	0.8	0, 20		4.6 M	58 M	116 M

rate (see table 2). It is assumed that the efficacy of antivirals (and vaccine too) in high-risk individuals is lower than that in low-risk individuals (Longini *et al.* 2004; Moscona 2005). We first consider the case when

antivirals are administered both therapeutically and prophylactically. We show that for a fixed 10 (low-risk) and 30% (high-risk) antiviral treatment, coverage of early-infectious individuals, and 100 values of the

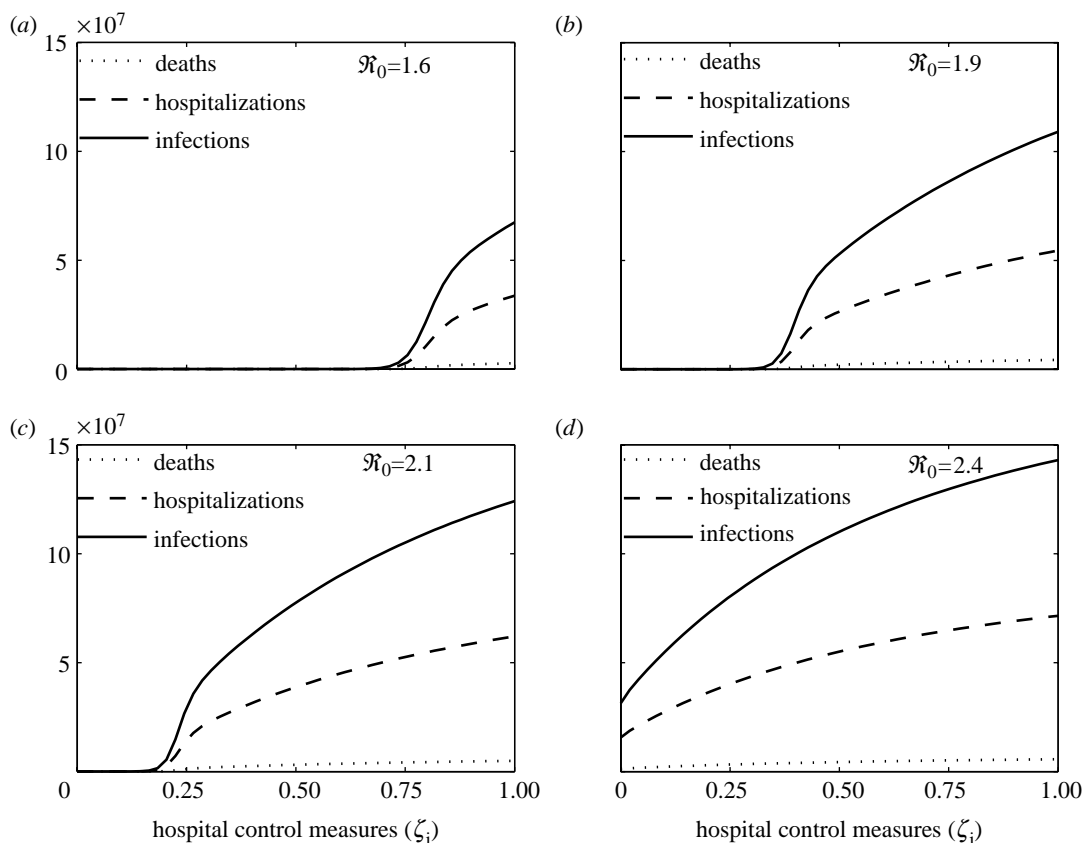

Figure 3. Baseline scenarios illustrating the final number of deaths (dotted line), hospitalizations (dashed line) and infections (solid line) for varying levels of hospital control measures. We assume a fixed 10% ($\pi_i=0.9$) reduction in community control measures and vary hospital control measures from 0 to 100% (ζ_i) for $\mathcal{R}_0=1.6, 1.9, 2.1$ and 2.4 .

antiviral efficacy uniformly sampled from the range (0.3,0.5) (i.e. assuming efficacy ranging from 30 to 50%), results in a mean average of 15 deaths, 194 hospitalizations and 426 infections (table 5). Similarly, sampling a 50–70% antiviral efficacy for low-risk individuals yields 13 deaths, 168 hospitalizations and 368 infections. In order to assess the impact of antiviral treatment alone (no prophylaxis), we assume the use of treatment only for both the upper- and lower-bound efficacy and treatment rates. We show that in the absence of antiviral prophylaxis, the less optimistic scenario (lower-bound efficacy and coverage rate) results in high morbidity (47 million hospitalizations and 105 million infections) and mortality (3.7 million deaths). For the optimistic (upper-bound) scenario, the numbers decreased significantly (to 6138 hospitalizations, 21 537 infections and 483 deaths). Further simulations (table 5) show that the singular use of antiviral prophylaxis is always more effective than using antivirals therapeutically. However, this intervention requires large number of doses that may not be attainable during a pandemic. In summary, our results for the antiviral-only scenario show that regardless of the coverage and efficacy levels, the most optimal scenario is based on the combined use of antivirals (treatment and prophylaxis). However, if optimistic coverage and efficacy levels can be achieved, antiviral treatment (alone) might reduce morbidity to as low as 27675 cases (compared to baseline estimates of 192 M)

and mortality of 483 (compared to baseline estimates of 5.1 M). This finding could be of practical utility because the therapeutic use of antivirals places relatively less demand on possibly scant antiviral resources.

The impact of the timely administration of antivirals is illustrated using contour plots of \mathcal{R}_{av}^i as a function of efficacy and antiviral coverage rates (figure 4). Assuming that antivirals are implemented within 24–48 h of exposure, we show (figure 4a,b) that a pandemic can be effectively controlled given high enough efficacy and coverage rates (to make $\mathcal{R}_{av}^i < 1$). However, a delayed implementation of more than 48 h significantly reduces the prospect of containing an outbreak (figure 4c). These simulations suggest that the use of antivirals alone might significantly mitigate a future pandemic in the US. However, a high enough efficacy must be achieved and a sufficient number of doses must be available and distributed. In particular, the time requirement for efficacy suggests that antiviral stores must be within almost immediate reach of symptomatic individuals.

This study shows that the combined use of antivirals (therapeutic and prophylactic) seems to be the most effective single-intervention strategy. Unfortunately, this strategy requires that a very large number of doses be available. Given that antivirals are expected to be limited in supply, our results suggest that restricting antivirals to therapeutic usage may be a pragmatic optimum since the number of doses required is dramatically lower.

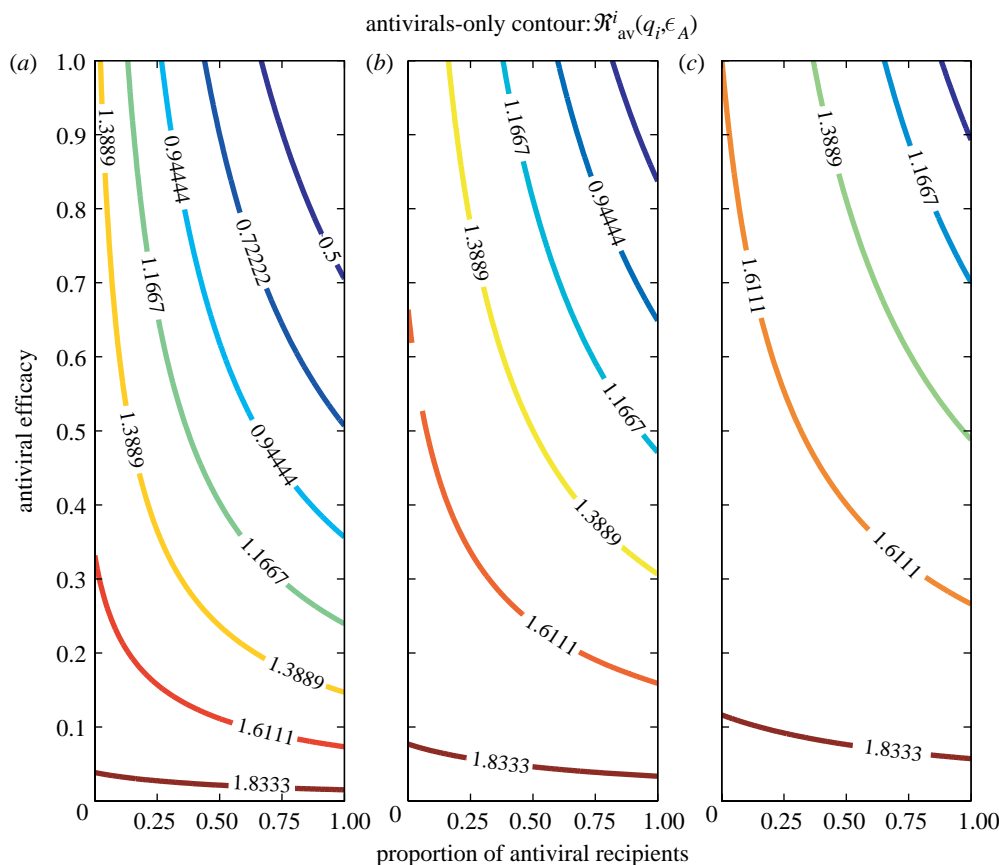

Figure 4. Contour plot of \mathcal{R}_{av}^i as a function of antiviral efficacy (ϵ_A). (a) An average time before antiviral intervention to latent and early-infectious individuals within 24 h ($\theta_i^{-1} = \xi_i^{-1} = 1$ day). (b, c) The case in which therapeutic antivirals are implemented in 48 ($\theta_i^{-1} = \xi_i^{-1} = 2$ days) and 72 h ($\theta_i^{-1} = \xi_i^{-1} = 3$ days), respectively. The remaining parameters used in this simulation are provided in table 1.

3.1.3. Vaccine-only intervention. Here, we explore the potential role of an anti-pandemic vaccine by assuming that a suitable vaccine is available at the onset of the pandemic. We evaluate four scenarios in which we allow for variability in vaccine efficacy for high- ($\epsilon_{V_h} \in (0.3, 0.5)$) and low-risk ($\epsilon_{V_l} \in (0.7, 0.9)$) individuals. We generate 100 model simulations by uniformly sampling the vaccine efficacy from the appropriate range. Assuming a per capita mean time to vaccination of approximately 2.7 days (lower-bound: $\nu_i = 0.368$) and allowing variability in vaccine efficacy between 30–50% (high-risk) and 70–90% (low-risk), we obtained mean estimates of 9–10 deaths, 91–106 hospitalizations and 177–208 infections (table 5). However, reducing the per capita mean time to vaccination to 1.5 days (upper-bound: $\nu_i = 0.655$), while still allowing for variability in vaccine efficacy as denoted in the previous case, reduces mortality to 7–8 cases, 76–86 hospitalizations and 148–175 infections (table 5). Overall, these simulations indicate that a vaccination programme (alone) can be highly effective; however, its success requires significantly high levels of vaccine efficacy and coverage to effectively control the pandemic (see contour plots in figure 5).

3.1.4. Combined interventions. The main thrust of the US preparedness plan is the combined use of several interventions. We begin our study by assessing the

potential impact of the combined use of antiviral medications and a vaccination campaign. We evaluate several scenarios allowing for variability in vaccine (ϵ_{V_i}) and antiviral (ϵ_{A_i}) efficacies for high- and low-risk individuals. The results, tabulated in table 7, show a mean of 5–6 deaths, 50–67 hospitalizations and 117–147 total infections. Simulating another combination, involving the use of transmission control measures and antivirals, results in 3–8 deaths, 31–94 hospitalizations and 102–207 infections. Thus, the latter combination seems to be better, on average, than the former. However, once a combined antiviral and vaccination programme is (widely) implemented, the use of transmission control measures offers only marginal benefit (mean of 3–5 deaths, 26–53 hospitalizations and 74–116 infections; table 7).

In summary, our results (US scenario) for single interventions with $\mathcal{R}_0 = 1.9$ show that the use of antivirals as treatment alone (with low coverage and efficacy levels) is always worse than the singular use of control measures, vaccine or prophylactic antivirals. The combined use of antiviral treatment and prophylaxis (with low coverage and efficacy levels) is more effective than the use of control measures but less optimal than using a vaccine. However, as antiviral coverage and efficacy levels are increased further (upper-bound parameters), the use of antivirals alone (both prophylactically and therapeutically) yield the

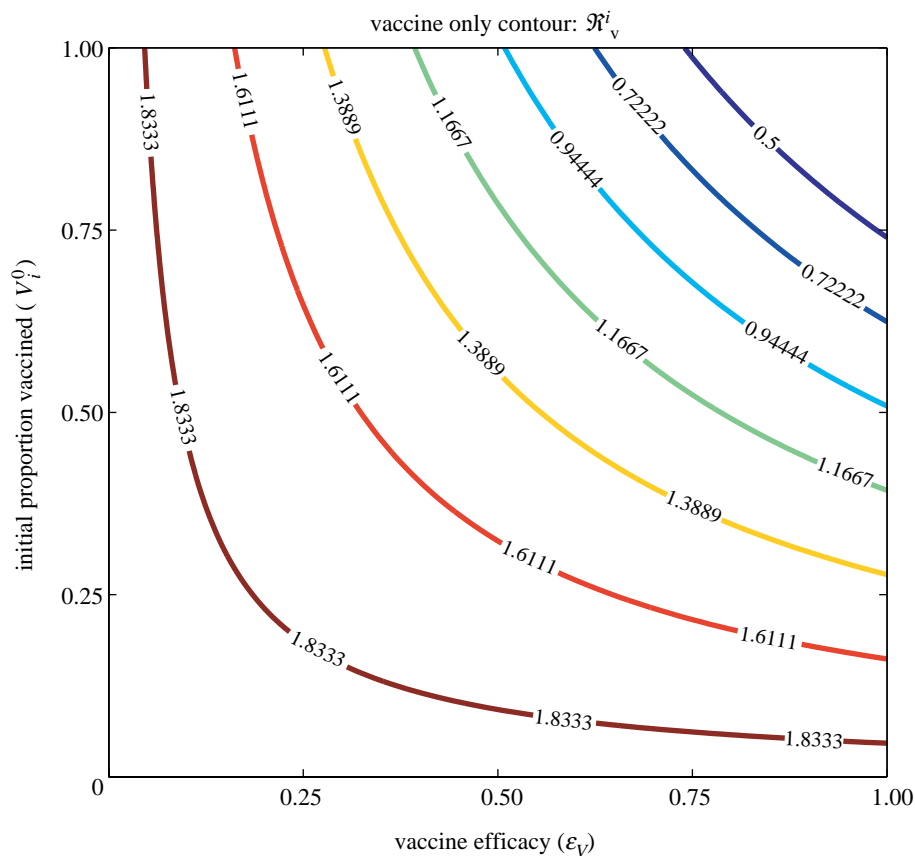

Figure 5. Contour plot of \mathcal{R}_v^i as a function of antiviral efficacy (ϵ_A) for fixed susceptible ($S_0^0 = 0.99$) and vaccinated ($V_0^0 = 0.01$) population proportions at the beginning of the outbreak. The remaining parameter values are provided in table 1.

Table 7. Mean results of 100 simulations generated by uniformly sampling the antiviral and vaccine efficacies from appropriate ranges as assumed in each scenario. Baseline scenario assumes $\mathcal{R}_0 = 1.9$. The mean number of deceased (D_{mean}), hospitalized (H_{mean}), infections (I_{mean}), antiviral treatment (T_{mean}), antiviral prophylaxis (P_{mean}) and vaccinated (C_{mean}) individuals. M, million; na, not applicable; ub and lb, upper- and lower-bound parameters presented in table 1.

combined interventions	D_{mean}	H_{mean}	I_{mean}	T_{mean}	P_{mean}	C_{mean}
antiviral–vaccine ^a						
lb: $\epsilon_{A_i}, \epsilon_{V_h} = 0.3, \epsilon_{V_k} \in (0.7, 0.9)$	6	60	131	46	69 M	300 M
lb: $\epsilon_{A_i}, \epsilon_{V_k} = 0.7, \epsilon_{V_h} \in (0.3, 0.5)$	6	67	147	50	69 M	300 M
ub: $\epsilon_{A_i}, \epsilon_{V_h} = 0.3, \epsilon_{V_k} \in (0.7, 0.9)$	5	50	117	58	94 M	300 M
ub: $\epsilon_{A_i}, \epsilon_{V_k} = 0.7, \epsilon_{V_h} \in (0.3, 0.5)$	5	56	129	62	94 M	300 M
control measures and antivirals ^b						
lb: $q_i, a_i, \epsilon_{A_k}, \zeta_i = \pi_i = 0.8, \epsilon_{A_h} \in (0.3, 0.5)$	8	94	207	72	124×10^8	na
ub: $q_i, a_i, \epsilon_{A_k}, \zeta_i = \pi_i = 0.8, \epsilon_{A_h} \in (0.3, 0.5)$	3	31	102	88	145×10^8	na
control measures, antivirals and vaccine ^c						
lb: $q_i, a_i, \nu_i, \epsilon_{A_i}, \epsilon_{V_k}, \zeta_i = \pi_i = 0.8, \epsilon_{V_h} \in (0.3, 0.5)$	5	53	116	40	69 M	300 M
ub: $q_i, a_i, \nu_i, \epsilon_{A_i}, \epsilon_{V_k}, \zeta_i = \pi_i = 0.8, \epsilon_{V_h} \in (0.3, 0.5)$	3	26	74	51	41 M	300 M

^a Mean of 100 simulations sampled from $\epsilon_{V_k} \in (0.7, 0.9)$ and $\epsilon_{V_h} \in (0.3, 0.5)$.

^b Mean of 100 simulations sampled from $\epsilon_{A_h} \in (0.3, 0.5)$.

^c Mean of 100 simulations sampled from $\epsilon_{V_k} \in (0.3, 0.5)$.

most optimal intervention. These results show that determining the most optimal single intervention depends strongly on the availability and efficacy levels of the resources.

For situations where antiviral supplies are limited, optimal (significantly reducing disease burden while requiring modest level of antiviral supplies) results are achieved by administering the antivirals

therapeutically, rather than prophylactically, as long as the efficacy of the antivirals is at least 50 and 70% for high- and low-risk groups, respectively (table 5). However, if antiviral supplies are sufficient to cover a large percentage of the population, their combined use (therapeutically and prophylactically) is highly optimal for efficacy levels as low as 30 (high-risk) and 50% (low-risk). The effectiveness of

antivirals as a single intervention relies on modest efficacy and coverage rate, the timely distribution of these drugs and large numbers of resources. We also show that although, for high coverage and efficacy, the vaccine-only intervention is not as effective as the antiviral-only strategy in reducing disease burden (table 5 and figure 5), it may still effectively control ($\mathcal{R}_v^i < 1$) and influenza pandemic given the expected limitation on the availability (and low efficacy) of antivirals at the onset of the pandemic. Finally, considering the uncertainty in the coverage and efficacy of antivirals and vaccine, our results here show that control measures alone can be more effective than antiviral treatment alone (for high coverage and efficacy) and rely on more feasible interventions.

While the combined interventions have been shown to be highly effective in reducing the burden of, and perhaps preventing ($\mathcal{R}_{c+v+av}^i < 1$), a flu pandemic (figure 6), here we allude to several challenges that may be involved in implementing such strategies. For instance, the rather high demands in vaccine and antiviral doses necessary to achieve these results may not be realistically attainable (table 7). Our study shows that the use of transmission control measures could be effective and should perhaps be explored as a realistic and cost-effective alternative. In fact, we show that the effective implementation of transmission control measures alone may significantly reduce the burden of a pandemic (figure 7).

Overall, while our results confirm the findings in Longini *et al.* (2004), namely that antivirals would, in general, be highly effective in reducing the burden of an outbreak (particularly when used in treatment and prophylaxis), our findings do not support the singular use of antivirals prophylactically. Our model suggests that unrealistically large number of doses would be needed under this strategy. The use of antivirals therapeutically (primarily) is a more feasible and effective intervention (for reasonable efficacy and coverage rates), given that antiviral doses are likely to be limited during a flu pandemic.

3.2. Evaluation scenarios for the UK

To assess the UK influenza preparedness plan (Department of Health Publications Pandemic Flu 2005), the model is used to investigate the impact of transmission control measures in the community and hospitals, antivirals- and vaccine-only, as well as, a combination of these interventions. We compare the findings of our model for the intervention scenarios considered in Gani *et al.* (2005). The baseline simulations for the UK, assuming $\mathcal{R}_0 = 1.9$ (in the absence of any interventions; table 4), result in 3.6% case-fatality percentage (933 514 deaths), 43% clinical (26 million infections) attack rate and 50% hospitalization rate (13 million hospitalizations).

The simulation results show that the use of transmission control measures (in hospitals and communities) alone can be highly effective in reducing morbidity and mortality. For instance, a 20% reduction in the transmission control measures reduces mortality

from 933 514 to 660 215, hospitalizations from 13 million to 9.1 million and infections from 26 million to 18 million (table 8). Further, assuming high coverage and efficacy of antivirals only for the UK results in additional reductions in these estimates (3 deaths, 34 hospitalizations and 120 infections). It is further shown that the vaccine-only scenario for the UK appears to be more effective, on average, than the antiviral-only intervention (table 8). Not surprisingly, similar to our findings for the US, we show that a combined intervention, that includes the use of transmission control measures, antivirals and vaccine, is the most effective strategy in reducing the burden of a potential pandemic in the UK.

Assuming an age-specific attack rate model with antiviral treatment, Gani *et al.* (2005) showed that the optimal intervention strategy during a flu pandemic was strongly dependent on the number of doses for the treatment available. In particular, their estimates (based on the 1957 pandemic) showed that hospitalizations could be reduced by 67% (first pandemic wave) for sufficiently large antiviral coverage (20–25% stockpile). Moreover, they further suggest that a reduction in hospitalizations of up to 36% could be achieved by treating 11–17% of the young and elderly population when only limited supplies are available. While Gani *et al.* (2005) did not evaluate the role of transmission control measures or a combination of antivirals and vaccine in reducing the impact of a potential pandemic, we show (table 8) that the combined use of these interventions results in as few as 64 infections, 18 hospitalizations and 2 deaths (assuming low-bound antiviral and vaccine efficacies).

Our results for the antiviral-only scenario agree with the findings by Gani *et al.* (2005), i.e. we show that the use of mass treatment with antivirals is highly effective in reducing the burden of a pandemic (table 8) assuming that sufficient doses of antivirals are available. Although our results suggest that vaccine alone is also highly effective in reducing the impact of a pandemic, the strategy assumes that a vaccine will be readily available at the onset of a pandemic. Hence, it is worth emphasizing that this latter scenario may seem unreasonable because an appropriate vaccine is unlikely to be available at the onset of the pandemic.

3.3. Evaluation scenarios for the Netherlands

Our model is used to explore some of the scenarios recommended in the Netherlands preparedness plan and comparisons are made with the results reported in the recent study by van Genungten *et al.* (2003), in which antivirals and vaccine (influenza and pneumococcal) are considered. Assuming no interventions with a baseline \mathcal{R}_0 value of 1.9 results in 7 million infections (42% CAR), 3.5 million hospitalizations and 252 511 deaths (3.6% CFP) (table 4). The use of transmission control measures alone (with $\pi_i = \zeta_i = 0.8$) reduces morbidity by 29% (table 8: case (i)). An antiviral-only strategy for the Netherlands, assuming upper-bound efficacy and coverage, results in a significant

Table 8. Summarized estimates of the total number of individuals treated with antiviral medications (T_{total}), individuals under antiviral prophylaxis (P_{total}) and protected individuals via vaccination (V_{total}) for the US, UK and the Netherlands for various intervention scenarios. Disease parameters and initial conditions for each country are provided in tables 2 and 3. Results reported in parenthesis correspond to two cases considered for each of the following intervention strategies: (i) assumes two scenarios ($\pi_i = \zeta_i = 1$; $\pi_i = \zeta_i = 0.8$), (ii) assumes (lower, upper) values for g_i , a_i and ϵ_{A_i} , (iii) assumes (lower, upper) values for ν_i and ϵ_{V_i} , and (i–iii) assumes (i), (ii) and (iii) simultaneously. See table 2 for lower- and upper-bound parameters used in these simulations. na, not applicable; M, million.

interventions	deaths	hospitalizations	infections	T_{total}	P_{total}	C_{total}
US prediction						
(i) control measures	(5.1 M; 3.6 M)	(64 M; 46 M)	(128 M; 91 M)	na	na	na
(ii) antivirals only	(12; 3)	(144; 33)	(351; 117)	(145; 107)	(122; 147) $\times 10^8$	na
(iii) vaccine only	(11; 5)	(116; 54)	(227; 104)	na	na	300 M ^a
(i–iii)	(5; 2)	(55; 19)	(120; 66)	(42; 64)	(69 M; 56 M)	300 M ^a
UK prediction						
(i) control measures	(933 514; 660 215)	(13 M; 9.1 M)	(26 M; 18 M)	na	na	na
(ii) antivirals only	(21; 3)	(281; 34)	(608; 120)	(180; 108)	(26; 31) $\times 10^8$	na
(iii) vaccine only	(8; 5)	(94; 49)	(184; 93)	na	na	61 M ^a
(i–iii)	(5; 2)	(51; 18)	(110; 64)	(37; 61)	(14 M; 11 M)	61 M ^a
The Netherlands prediction						
(i) control measures	(252 511; 178 587)	(3.5 M; 2.5 M)	(7 M; 5 M)	na	na	na
(ii) antivirals only	(21; 3)	(281; 34)	(608; 120)	(180; 108)	(69; 83) $\times 10^7$	na
(iii) vaccine only	(8; 5)	(94; 49)	(183; 93)	na	na	16 M ^a
(i–iii)	(5; 2)	(51; 18)	(110; 64)	(37; 61)	(3.8 M; 3.1 M)	17 M ^a

^a C_{total} resources needed similar in both (iii) and (i–iii) scenarios considered.

decrease in morbidity and mortality (120 total infections, 34 hospitalizations and 3 deaths; table 8: case (ii)). Although the Netherlands plan does not anticipate the availability of a vaccine at the onset of the pandemic, the impact of a hypothetical vaccination scenario was also explored. We show that the burden of a pandemic can be reduced to as few as 93 infections, 49 hospitalizations and 5 deaths for a vaccine with upper-bound efficacy and coverage (table 8: case (iii)). Similar to the intervention scenarios for the other two countries, the combined intervention gives the best results for the Netherlands, giving as few as 64–110 infections, 18–51 hospitalizations and 2–5 deaths (table 8: case (i–iii)).

Our results agree with the findings by van Genugten *et al.* (2003) regarding the role of combined interventions in reducing the impact of a pandemic. However, for the vaccine- and antiviral-only scenarios, our conclusions differ significantly, i.e. while our results suggest that vaccination can be highly effective in reducing the impact of a pandemic, the study by van Genugten *et al.* (2003) seems to underestimate the impact of vaccination in the control of the pandemic. The differences in these results may be due to a number of factors including our assumption that a vaccine is available at the start of the pandemic, differences in vaccine efficacy assumptions and our dynamical systems approach which differ from their scenario-analysis model. However, our study agrees with one of the main conclusions by van Genugten *et al.* (2003) in

that antiviral treatment only is highly effective in reducing the impact of a potential flu pandemic.

4. DISCUSSION

Judging from the devastating experience of earlier pandemics, especially the 1918 pandemic, outbreaks arising from a future flu pandemic are expected to inflict major public health and socio-economic burden across the globe. Estimates of the expected number of infections and pandemic-related mortality and hospitalizations are simply staggering (Meltzer *et al.* 1999; van Genugten *et al.* 2002; Department of Health Publications Pandemic Flu 2005; National Strategy for pandemic Influenza Implementation Plan 2006).

Combating such a deadly disease clearly requires well-coordinated global efforts involving public health agencies, governmental organizations and other stakeholders. Fortunately, partial efforts are already underway and a number of countries (Uscher-Pines *et al.* 2006) have formulated pandemic flu preparedness plans. These plans are based on a number of preventive and therapeutic measures that generally involve the use of antivirals, vaccination and basic public health measures for minimizing transmission in hospitals and/or communities.

A number of mathematical modelling studies, using stochastic as well as deterministic formulations, have been carried out to quantify the burden of a potential flu pandemic and assess various interventions (e.g. van

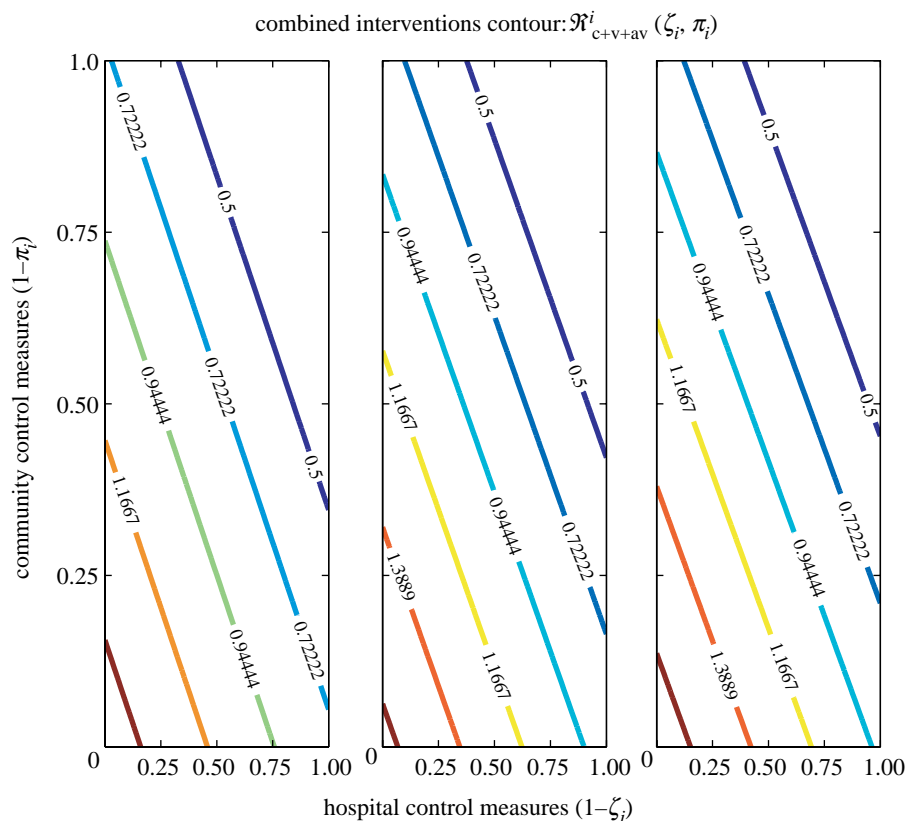

Figure 6. Contour plot of $\mathcal{R}_{\text{eff}}^i$ as a function of infection control measures via hospital ($1-\zeta_i$) and community ($1-\pi_i$) transmission reduction factors. (a) Results when the antiviral medications are administered within 24 h to latent, asymptomatic and early-infectious individuals ($\theta_i^{-1} = \xi_i^{-1} = 1$ day). (b,c) The case in which therapeutic antivirals are implemented within 48 h ($\theta_i^{-1} = \xi_i^{-1} = 2$ days) and 72 h ($\theta_i^{-1} = \xi_i^{-1} = 3$ days), respectively. The remaining parameters used in this simulation are provided in table 1.

Genugten *et al.* 2003; Longini *et al.* 2004; Ferguson *et al.* 2005, 2006; Gani *et al.* 2005; Longini & Halloran 2005; Germann *et al.* 2006). Although the findings in these studies seem reassuring, these studies assume that anti-pandemic resources (such as antivirals and a vaccine) are widely available at the beginning of the pandemic. This assumption may, of course, not be realistic, especially in some resource-poor nations.

We used a mathematical model to study the potential effect of a number of intervention strategies from basic public health interventions to antivirals (treatment and prophylaxis) and the possibility of a vaccination campaign. Our work extends earlier studies by incorporating and assessing some of the main intervention strategies associated with the pandemic preparedness plans of the US, UK and the Netherlands. The main interventions considered here are the use of (i) transmission reduction control measures (in hospitals and communities), (ii) antivirals (both prophylactically and therapeutically), and (iii) the possibility of a vaccination programme. For items (ii) and (iii), the effect of the uncertainty on the efficacy, coverage and administration rates (table 2) is considered.

We show that although combined interventions give the most optimal results, a strategy that emphasizes the use of basic transmission control measures (such as quarantine, isolation and other measures that reduce the contact rate within communities and hospitals) could

have a significant impact on the control of an influenza pandemic. While the use of vaccines and antivirals (the key components of the combined intervention strategy) is expected to suffer a number of availability and logistical setbacks at the onset of a pandemic (and, possibly, throughout the duration of the pandemic), the efficient implementation of a programme based on reducing transmission in hospitals and communities offers significant benefits (table 6) and requires non-pharmaceutical interventions.

If single interventions are to be adopted, then the use of vaccine was found to be the most effective of the three interventions considered low efficacy and coverage levels of the interventions (vaccine and antivirals). However, as coverage and efficacy levels are increased, the antiviral-only intervention (offered as a prophylaxis and treatment) yields the most optimal result (table 5). Not surprisingly, the impact of antiviral- and vaccine-only interventions strongly depends on the number of doses available (table 5). In particular, our results suggest that countries with limited antiviral supplies should opt for its implementation strictly as a therapeutic agent rather than as a prophylaxis. The effectiveness of antiviral treatment alone is particularly evident for reasonably modest efficacy (50–70%) and coverage (50–70%) rates. However, if the number of doses is sufficiently large (to cover a significant proportion of the population), the use of antivirals

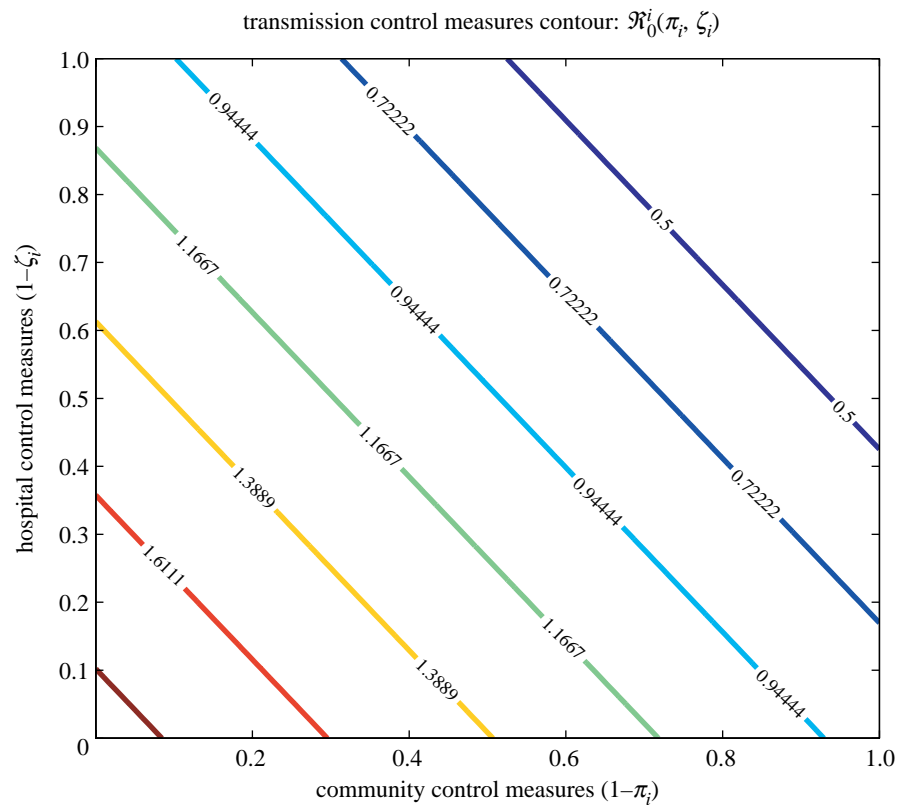

Figure 7. Contour plot of \mathcal{R}_0^i as a function of infection control measures via hospital ($1 - \zeta_i$) and community ($1 - \pi_i$) transmission reduction factors.

both therapeutically and prophylactically gives the most optimal result (in comparison with using them prophylactically or therapeutically only) even for low efficacy and coverage rates.

Further, in addition to the availability and efficacy of the antivirals, the success of an antiviral-only intervention will depend on its timely distribution. For instance, we showed that treating infectious individuals in early symptomatic stage (within 48 h of the onset of symptoms) can result in the effective control of the pandemic for reasonable antiviral coverage and efficacy levels. However, a delay in implementation (past 48 h) reduces the probability of achieving such control significantly (figure 4).

Although one of the key findings in this study is that the combined intervention is the most 'optimal' strategy for combatting a pandemic in each of the three chosen countries, it is worth emphasizing that a pandemic event would most probably impose severe burden on public health resources. It is certainly plausible to expect that the key control resources (antivirals and vaccine) would not be widely available (if at all, in some nations) at the onset of a pandemic. One important contribution of this study is that it allows for the assessment of other interventions that do not rely on these resources, namely the use of non-pharmaceutical basic public health interventions to curtail transmission in hospitals and communities. Our results indicate that these interventions (control measures) are highly effective (at least during the early stages of a pandemic) and should also be emphasized in the existing preparedness plans.

Considering the current preparedness plans for the US, UK and the Netherlands, our results support the considerations of the UK and the Netherlands plans in that antiviral drugs should be used primarily for treatment rather than prophylactically. The use of antivirals for prophylaxis involves follow-up periods that could be as long as the duration of the pandemic itself; hence, it would require a significant number of doses that are unlikely to be available on time in most countries. This requires the consideration of other 'next-best' preparedness plans (at least until a vaccine becomes available). This is in recognition of the number of key challenges associated with the administration of antivirals for prophylaxis. Our study strongly supports the plans of the UK and the Netherlands, vis-à-vis the therapeutic use of antivirals to control a flu pandemic.

It is worth mentioning that most of the recent modelling studies on pandemic influenza have generally used large-scale stochastic simulation models to study nationwide spread of influenza (Longini *et al.* 2004, 2005; Ferguson *et al.* 2005, 2006; Longini & Halloran 2005; Germann *et al.* 2006). This certainly differs from our simpler approach that uses a deterministic dynamical model (see also van Genugten *et al.* 2003; Arino *et al.* 2006; Brauer 2006; Chowell *et al.* 2006). No doubt that these detailed simulation studies have provided reasonable estimates and assessments of the potential impact of a flu pandemic. However, their actual (computer) implementation seems to rely on using state-of-the-art computing resources (e.g. supercomputers) and highly specific data, which are unlikely to be

available in most countries (especially at the onset of a pandemic; Germann *et al.* 2006). For instance, the stochastic simulation models cited above assume some or all of the following: (i) high-resolution population density information, (ii) individual-level transmission patterns, (iii) detailed contact structure, and (iv) age-specific disease-related parameters, to name a few, while the model proposed in our study assumes only a simple population structure (i.e. high- and low-risk classes) and uses parameter values of influenza epidemiology, many of which are well known (table 2). The relative ease of implementation of the modelling approach presented in this paper, along with the fact that the conclusions it provides are plausible (and compare reasonably well with some of the large, computationally intensive, stochastic simulation models such as those reported in Ferguson *et al.* (2005, 2006), Longini *et al.* (2004, 2005), Longini & Halloran (2005), and Germann *et al.* (2006) makes it a relatively attractive modelling approach. Further, our dynamical system approach offers an improvement to the ‘scenario-analysis model’ discussed in van Genugten *et al.* 2003.

Overall, this study shows that the prospect of combatting the next flu pandemic is promising, provided a number of control measures (especially the use of a combined intervention strategy) are put in place in an efficient manner. An additional reassuring aspect of this study is that basic public health control measures have the potential to have a significant impact in reducing the burden of an influenza pandemic.

M.N. was partially funded by the Yerby Postdoctoral Fellowship and National Institutes of Health grant T32AI07358. G.C. was supported by a Director’s Postdoctoral Fellowship from Los Alamos National Laboratory. A.B.G. acknowledges the support, in part, of the Natural Science and Engineering Research Council (NSERC) and Mathematics of Information Technology and Complex Systems (MITACS) of Canada. The authors are thankful to the anonymous reviewers for their very valuable comments, which have enhanced the paper. The authors are also grateful to Professor Marc Lipsitch (Harvard School of Public Health) and Dr Thomas A. Reichert (Entropy Research Institute) for many useful suggestions during the preparation and revision of the manuscript.

APPENDIX A

Recall that the *combination reproduction number* is given by

$$\mathcal{R}_{c+v+av}^i = \left(\frac{\pi_i \beta_i \eta_i (1-a_i)(1-p)\phi_i}{\mathcal{B}_i \mathcal{C}_i} + \frac{\pi_i \beta_i x_i}{\mathcal{A}_i \mathcal{B}_i} + \frac{\pi_i \beta_i x_i y_i}{\mathcal{A}_i \mathcal{B}_i \mathcal{D}_i} + \frac{\zeta_i \beta_i x_i y_i \alpha_i}{\mathcal{A}_i \mathcal{B}_i \mathcal{D}_i \mathcal{E}_i} \right) \mathcal{S}_{\text{eff}}^0,$$

where $x_i = (1-a_i)p\phi_i$, $y_i = (1-\epsilon_{A_i}q_i)\psi_i$, $\mathcal{A}_i = \epsilon_{A_i}\xi_i q_i + (1-\epsilon_{A_i}q_i)\psi_i$, $\mathcal{B}_i = a_i\epsilon_{A_i}\theta_i + (1-a_i)\phi_i$, $\mathcal{C}_i = (\epsilon_{A_i}\theta_i + \gamma_{A_i})$, $\mathcal{D}_i = \gamma_{I_i} + \alpha_i$, $\mathcal{E}_i = \gamma_{H_i} + \delta_i$ and $\mathcal{S}_{\text{eff}}^0 = (S_i^0 + (1-\epsilon_{V_i})V_i^0)/N^0$. It can be observed that \mathcal{B}_i^{-1} , \mathcal{C}_i^{-1} , \mathcal{A}_i^{-1} , \mathcal{D}_i^{-1} and \mathcal{E}_i^{-1} describe the average time spent in L_i , A_i , I_{i_1} , I_{i_2} and H_i , respectively. The *combination reproduction number*

can be rewritten as follows:

$$\mathcal{R}_{c+v+av}^i = \left(\pi_i \beta_i \eta_i \mathcal{F}_1^i \frac{1}{\mathcal{C}_i} + \pi_i \beta_i \mathcal{F}_2^i \frac{1}{\mathcal{A}_i} + \pi_i \beta_i \mathcal{F}_2^i \mathcal{F}_3^i \frac{1}{\mathcal{D}_i} + \zeta_i \beta_i \mathcal{F}_2^i \mathcal{F}_3^i \mathcal{F}_4^i \frac{1}{\mathcal{E}_i} \right) \mathcal{S}_{\text{eff}}^0, \quad (\text{A } 1)$$

where

$$\mathcal{F}_1^i = \frac{(1-a_i)(1-p)\phi_i}{\mathcal{B}_i}, \quad \mathcal{F}_2^i = \frac{(1-a_i)p\phi_i}{\mathcal{B}_i},$$

$$\mathcal{F}_3^i = \frac{(1-\epsilon_{A_i}q_i)\psi_i}{\mathcal{A}_i}, \quad \mathcal{F}_4^i = \frac{\alpha_i}{\mathcal{D}_i},$$

represent the fraction of individuals progressing to the various infectious classes. For instance, \mathcal{F}_1^i denotes the fraction of L_i individuals that progress to A_i , \mathcal{F}_2^i is the fraction of individuals in L_i class that progress to I_{i_1} , \mathcal{F}_3^i denotes the fraction of I_{i_1} that progress to I_{i_2} and \mathcal{F}_4^i denotes the fraction of individuals that progress from I_{i_2} to H_i .

Each contribution in \mathcal{R}_{c+v+av}^i involves (i) the product of the infectiousness ($\pi_i\beta_i$ or $\zeta_i\beta_i$) due to reduction in community or hospital transmission for the i -risk individuals and susceptibles, (ii) the fraction of individuals that progress to a particular infectious class (\mathcal{F}_1^i , \mathcal{F}_2^i , \mathcal{F}_3^i and \mathcal{F}_4^i), and (iii) the average time spent in each infectious class (\mathcal{C}_i^{-1} , \mathcal{A}_i^{-1} , \mathcal{D}_i^{-1} and \mathcal{E}_i^{-1}).

It is worth stating that the threshold \mathcal{R}_{c+v+av}^i can be rewritten in terms of the contributions from the i -risk individual progressing through the various stages of disease in the presence of interventions as follows:

$$\mathcal{R}_{c+v+av}^i = \mathcal{R}_{\text{Asympt}}^i + \mathcal{R}_{\text{Early Infection}}^i + \mathcal{R}_{\text{Late Infection}}^i + \mathcal{R}_{\text{Hospitalized}}^i. \quad (\text{A } 2)$$

The first term in (A 2) describes the contribution of asymptomatic partially infectious individuals (A_i), the second and third terms denote the contribution of early- and late-stage infectious individuals I_{i_1} and I_{i_2} , and the last term denotes the contribution of the hospitalized individuals H_i .

REFERENCES

- Arino, J., Brauer, F., van den Driessche, P., Watmough, J. & Wu, J. 2006 Simple models for containment of a pandemic. *J. R. Soc. Interface* **3**, 453–457. (doi:10.1098/rsif.2006.0112)
- Brauer, F. 2006 Some simple epidemic models. *Math. Biosci. Eng.* **3**, 1–15.
- Blitz, S. G. 2000 Developments on the care of influenza patients: priorities and perspectives. *JCOM* **7**, 63–72.
- Butler, D. 2006 Disease surveillance needs a revolution. *Nature* **440**, 6–7. (doi:10.1038/440006a)
- Center for Disease Control and Prevention 2003 Prevention and control of influenza: recommendations of the advisory committee on immunization practices (ACIP). *MMWR* **52**, 1–34. [No. RR-8]
- Chowell, G., Ammon, C. E., Hengartner, N. W. & Hyman, J. M. 2006 Transmission dynamics of the great influenza pandemic of 1918 in Geneva, Switzerland: assessing the effects of hypothetical interventions. *J. Theor. Biol.* **241**, 193–204. (doi:10.1016/j.jtbi.2005.11.026)

- Cox, R. J., Brokstad, K. A. & Ogra, P. 2004 Influenza virus: immunity and vaccination Strategies. Comparison of the immune response to inactivated and live, attenuated influenza vaccines. *Scand. J. Immunol.* **59**, 1–15. (doi:10.1111/j.0300-9475.2004.01382.x)
- Demicheli, V., Rivetti, D., Deeks, J. J. & Jefferson, T. O. 2004 Vaccines for preventing influenza in healthy adults. *Cochrane Database Syst. Rev.* **3**, CD001269.
- Department of Health Publications Pandemic Flu: UK Influenza Pandemic Contingency Plan, October 2005. <http://www.dh.gov.uk/PolicyAndGuidance/Emergency-Planning/PandemicFlu/fs/en>, Accessed on June 1, 2006.
- Diekmann, O., Heesterbeek, J. A. P. & Metz, J. A. 1990 On the definition and the computation of the basic reproduction ratio R_0 in models for infectious diseases in heterogeneous populations. *J. Math. Biol.* **28**, 365–382. (doi:10.1007/BF00178324)
- Ferguson, N. M., Cummings, D. A. T., Cauchemez, S., Fraser, C., Riley, S., Meeyai, A., Iamsirithaworn, S. & Burke, D. S. 2005 Strategies for containing an emerging influenza pandemic in Southeast Asia. *Nature* **437**, 209–214. (doi:10.1038/nature04017)
- Ferguson, N. M., Cummings, D. A. T., Fraser, C., Cajka, J. C., Cooley, P. C. & Burke, D. S. 2006 Strategies for mitigating an influenza pandemic. *Nature (Letters)* **442**, 448–452. (doi:10.1038/nature04795)
- Gani, R., Hughes, H., Fleming, D., Griffin, T., Medlock, J. & Leach, S. 2005 Potential impact of antiviral drug use during influenza pandemic. *Emerg. Infect. Dis.* **11**, 1355–1362.
- Gerdil, C. 2003 The annual production cycle for influenza vaccine. *Vaccine* **21**, 1776–1779. (doi:10.1016/S0264-410X(03)00071-9)
- Germann, T. C., Kadau, K., Longini, I. M. & Macken, C. A. 2006 Mitigation strategies for pandemic influenza in the United States. *Proc. Natl Acad. Sci. USA* **103**, 5935–5940. (doi:10.1073/pnas.0601266103)
- Goodwin, K., Viboud, C. & Simonsen, L. 2005 Antibody response to influenza vaccination in the elderly: a quantitative review. *Vaccine* **24**, 1159–1169. (doi:10.1016/j.vaccine.2005.08.105)
- Jefferson, T., Smith, S., Demicheli, V., Harnden, A., Rivetti, A. & DiPietrantonj, C. 2005 Assessment of the efficacy and effectiveness of influenza vaccines in healthy children: systematic review. *Lancet* **365**, 773–780.
- Longini, I. M. & Halloran, M. E. 2005 Strategy for distribution of influenza vaccine to high-risk groups and children. *Am. J. Epidemiol.* **161**, 303–306. (doi:10.1093/aje/kwi053)
- Longini, I. M., Halloran, M. E., Nizam, A. & Yang, Y. 2004 Containing the pandemic influenza with antiviral agents. *Am. J. Epidemiol.* **159**, 623–633. (doi:10.1093/aje/kwh092)
- Longini, I. M., Nizam, A., Xu, S., Ungchusak, K., Hanshaowarakul, W., Cummings, D. A. T. & Halloran, M. E. 2005 Containing pandemic influenza at the source. *Science* **309**, 1083–1087. (doi:10.1126/science.1115717)
- Meltzer, M. I., Cox, N. J. & Fukuda, K. 1999 The economic impact of pandemic influenza in the United States: priorities for intervention. *Emerg. Infect. Dis.* **5**, 659–671.
- Mills, C. E., Robins, J. M. & Lipsitch, M. 2004 Transmissibility of 1918 pandemic influenza. *Nature* **432**, 904–906. (doi:10.1038/nature03063)
- Monto, A. S. 2003 The role of antivirals in the control of influenza. *Vaccine* **21**, 1796–1800. (doi:10.1016/S0264-410X(03)00075-6)
- Moscona, A. 2005 Neuraminidase inhibitors for influenza. *N. Engl. J. Med.* **353**, 1363–1373. (doi:10.1056/NEJMra050740)
- National Strategy for pandemic Influenza Implementation Plan, Homeland Security Council, May 2006.
- Nicholson, K. G., Webster, R. G. & Hay, A. J. 1998 *Textbook of influenza*. Oxford, UK: Blackwell Science Ltd.
- Oxford, J. S., Novelli, P., Sefton, A. & Lambkin, R. 2002 New millennium antivirals against pandemic and epidemic influenza: the neuraminidase inhibitors. *Antivir. Chem. Chemother.* **13**, 205–217.
- Potter, C. W. & Oxford, J. S. 1979 Determinants of immunity to influenza infection in man. *Br. Med. Bull.* **35**, 69–75.
- Stuart-Harris, C. 1979 Epidemiology of influenza in man. *Br. Med. Bull.* **35**, 3–8.
- Stiver, G. 2003 The treatment of influenza with antiviral drugs. *CMAJ* **168**, 49–56.
- The World Factbook <http://www.cia.gov/cia/publications/factbook/index.html>. Accessed on June 1, 2006.
- Thompson, W. W., Shay, D. K., Weintraub, E., Brammer, L., Bridges, C. B., Cox, N. J. & Fukuda, K. 2004 Influenza-associated hospitalizations in the United States. *JAMA* **292**, 1333–1340. (doi:10.1001/jama.292.11.1333)
- Uscher-Pines, L., Omer, S. B., Barnett, D. J., Burke, T. A. & Balicer, R. D. 2006 Priority setting for pandemic influenza: an analysis of national preparedness plans. *PLoS Med.* **3**, 1721–1727. (doi:10.1371/journal.pmed.0030436)
- van den Driessche, P. & Watmough, J. 2002 Reproduction numbers and sub-threshold endemic equilibria for compartmental models of disease transmission. *Math. Biosci.* **180**, 29–48. (doi:10.1016/S0025-5564(02)00108-6)
- van Genugten, M. L., Heijnen, M. L. & Jager, J. C. 2002 Scenario analysis of the expected number of hospitalisations and deaths due to pandemic influenza in the Netherlands, RIVM report 282701002
- van Genugten, M. L., Heijnen, M. L. & Jager, J. C. 2003 Pandemic influenza and healthcare demand in the Netherlands: scenario analysis. *Emerg. Infect. Dis.* **9**, 531–538.